



ULTRAMAT Impressions has been designed for buildings where corporate imagery is intrinsic to the visitor experience and needs to be included for subtle brand reinforcement. You can extend branding to the entrance to your premises using a high-quality matting system featuring your logo or corporate message.

All entrance matting from Birrus can be customised to fit any shape and size.



SYSTEM APPLICATIONS

Interior and Covered/Partially Covered Exterior.

Highly Recommended for:

- Commercial Buildings
- Facilities
- Office & Corporate Buildings
- Shops, Restaurants & Cafés
- Sports & Big Event Venues
- Civic Buildings
- Hospitals & Healthcare Facilities
- Storage Facilities
- Schools & Educational
- Car Parks
- Airports
- Warehouses
- Factories



ULTRAMAT Impressions

Luxury - Quality - Reputation



TECHNICAL SPECIFICATION

GENERAL

- 10-Year warranty
- Slip and fire tested to Australian standards
- VOC tested and adhesive-free
- End-of-life return to manufacturer option
- Global GreenTag certified - Level A

INSERTS

- Wider 75mm treads
- Your logo or corporate message - engraved plate
- Rebated inserts
- Insert replacement option
 - Loop pile insert specification:
 - 4 Standard colour options
 - Insert material: loop pile carpet
 - Yarn: Type 6 nylon
 - Pile weight: 814g/m²
 - Machine gauge: 1/12th gauge
 - Colour system: 100% solution-dyed nylon
 - Pile height: 4mm (+/- 0.5mm)
 - Total thickness: 7.5mm (+/- 0.5mm)
 - Backing: Glasbac (R), Glasbac (R) RE
 - Cut pile insert specification:
 - 7 standard colour options
 - Insert material: cut pile carpet
 - Yarn: yarn-dyed nylon
 - Pile weight: 1000g/m²
 - Machine gauge: 1/10th gauge
 - Total thickness: 9.0mm

EXTRUSIONS

- 6000-Series aluminium
- 75mm non-slip, furrowed treads
- Closed construction
- 10mm
- Finishing options:
 - Mill finish (silver)
 - Clear/natural anodised (15-micron)
 - Antique bronze anodised (15-micron)
 - Precious gold anodised (15-micron)
 - Midnight black anodised (25-micron)

www.birrusmatting.com.au

STANDARD INSERT COLOURS

Custom colours available by special order

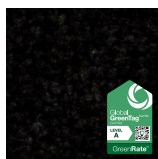

JET BLACK
Cut Pile

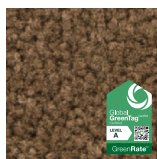

LATTE
Cut Pile



SLATE
Cut Pile

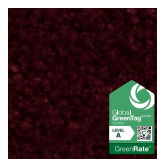

CLARET
Cut Pile

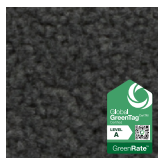

ASH
Cut Pile

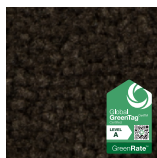

BROWNSTONE
Cut Pile

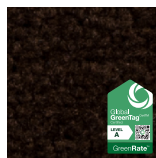

CHOCOLATE
Cut Pile

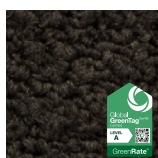

ASPHALT
Loop Pile

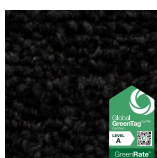

COAL
Loop Pile



CHARCOAL
Loop Pile



DUSK
Loop Pile



ULTRAMAT Impressions
Customisable Branding Strip Print Options



LEARN
MORE



REQUEST
A QUOTE



REQUEST
A SAMPLE



SUSTAINABLE
SYSTEMS

ULTRAMAT Impressions PROFILE DIAGRAM

10mm Closed Construction - Standard Installation

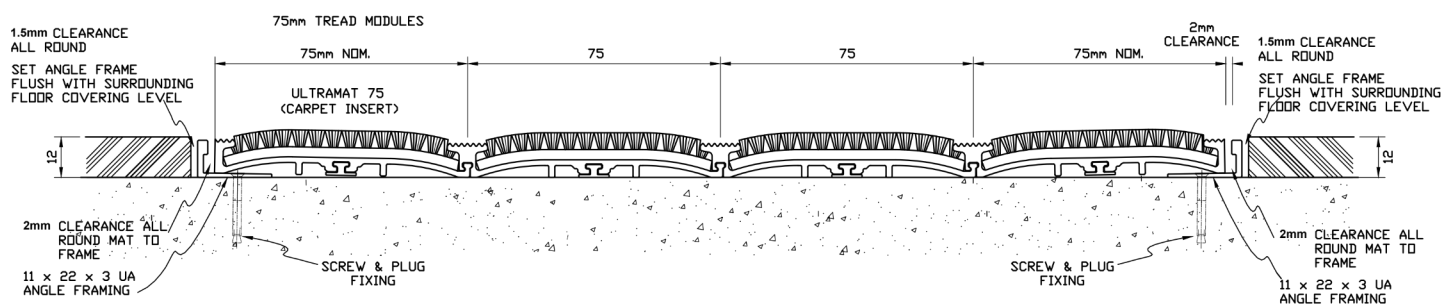

SYSTEM INSTALLATION

Birrus Installation Service is available – contact us for details.

Birrus Matting Systems require an internal recess depth of 12mm (10mm mat).

Standard Birrus matwell frames are fabricated using aluminium alloy, brass or stainless-steel angle for compatibility with our mats.

Place an angle in the recess and set angles level with adjoining floor surfaces. Glue in or screw fix as required. Contractors are advised to ensure proper performance of the entire assembly, it is absolutely necessary that the base of the matwell is formed to a level plane, using an engineered screed. We do not recommend sand and cement screed as it will break up over time.

A stepped profile (surface-mounted ramped), requires a minimum of 10mm clearance if a door is to pass over the mat.

CARE & MAINTENANCE

Vacuum clean matting regularly and, if required, spot clean carpet inserts with dry shampoo or steam clean as required.

Please contact us to purchase replacement inserts.